

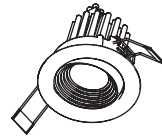

# SPOTLIGHTS



## SPOTS

58

RECESSED  
DIRECTIONAL  
FRAMELESS



## CUADRO

62

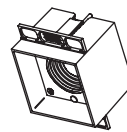

## SQUARES

66

RECESSED  
DIRECTIONAL  
FRAMELESS



Puoi trovare prodotti appartenenti alla stessa famiglia nei nostri cataloghi precedenti.

*Find out similar products in our older editions.*

# SPOTS



85  
CRI

TOP  
LEDs

95%  
OPTICS



RECESSED

ORIENTABLE

FRAMELESS

I faretti da incasso a soffitto SPOTS, innovativi e performanti, rappresentano un prodotto particolarmente versatile e discreto. L'ottimo comfort visivo è garantito dal circuito MultiLED arretrato su di un anello antiabbagliamento.

È possibile scegliere SPOTS da 1 a 6 LEDs di diverse dimensioni per accontentare tutte le esigenze, in versione ORIENTABLE con corpo luminoso basculante e FRAMELESS senza flangia per incassi a scomparsa.

Il corpo è in pressofusione di alluminio, disponibile nelle colorazioni bianco, nero e nichel spazzolato.

È possibile scegliere tra un'ampia varietà di ottiche a seconda delle esigenze: con l'ottica 8° è possibile esaltare, con un'illuminazione d'accento, dettagli e caratteristiche dei prodotti esposti; con la lente MONO OPTIC 120° si ottiene un'illuminazione ambientale nitida che garantisce il massimo comfort visivo. Fissaggio con molle per controsoffitto. Driver non compreso.

*SPOTS are innovative high-performance recessed ceiling spotlights that represent an extremely versatile subtle lighting system. The recessed MultiLED system with anti-glare ring ensures superb visual comfort.*

*SPOTS are available in different sizes with 1 to 6 LEDs to meet all needs. Choose between the DIRECTIONAL version with tilting light source or FRAMELESS version without flange for concealed mounting.*

*Pressure die-cast aluminium body available in white, black and brushed nickel finish.*

*Wide range of optics to answer all needs. 8° optics for accent lighting highlighting details and features of products on display and 120° MONO OPTIC lens to provide clear lighting for perfect visual comfort. Mounting system with self-retaining clips for false ceilings. Driver not included.*

# RECESSED

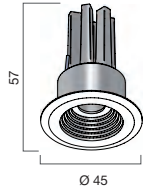

## 1 LED 2W 630mA

**Kg** 0,07 Kg  
**Vol** 0,2 dm<sup>3</sup>

Wh	91896
Bl	91897
Ni	91898

○ N 189 lm  
○ W 166 lm

▲ 08	8°
▲ 15	15°
▲ 30	30°
▲ 60	60°
▲ 12	120° Mono

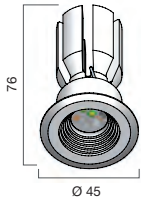

## 3 LEDs 6W 630mA

**Kg** 0,09 Kg  
**Vol** 0,2 dm<sup>3</sup>

Wh	91905
Bl	91906
Ni	91907

○ N 568 lm  
○ W 498 lm

▲ 15	15°
▲ 30	30°
▲ 60	60°
▲ 12	120° Mono

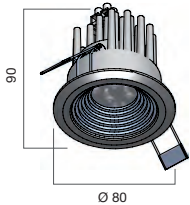

## 3 LEDs 6W 630mA

**Kg** 0,24 Kg  
**Vol** 1,2 dm<sup>3</sup>

Wh	92924
Bl	92925
Ni	92926

○ N 568 lm  
○ W 498 lm

▲ 15	15°
▲ 30	30°
▲ 60	60°
▲ 12	120° Mono

## 4 LEDs 8W 630mA

**Kg** 0,24 Kg  
**Vol** 1,2 dm<sup>3</sup>

Wh	91908
Bl	91909
Ni	91910

○ N 757 lm  
○ W 664 lm

▲ 15	15°
▲ 30	30°
▲ 60	60°

## 6 LEDs 12W 630mA

**Kg** 0,24 Kg  
**Vol** 1,2 dm<sup>3</sup>

Wh	91911
Bl	91912
Ni	91913

○ N 1135 lm  
○ W 997 lm

▲ 08	8°
▲ 30	30°
▲ 60	60°
▲ 12	120° Mono

### ELETTRONICA ELECTRONICS

	1-2 LEDs 630mA	89147
	1-6 LEDs 630mA	89164
	6-12 LEDs 630mA	84766

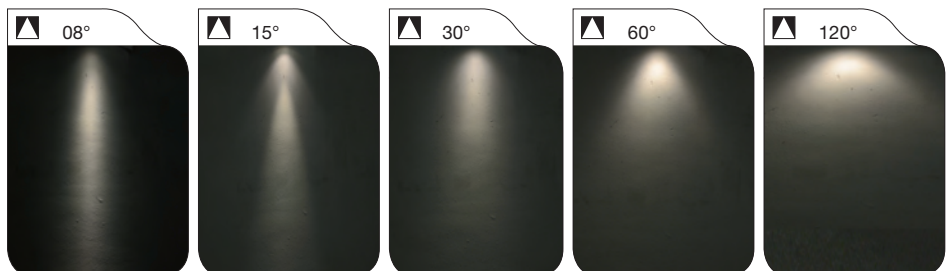

DIRECTIONAL

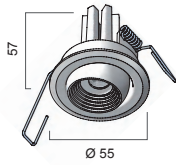

**1 LED**  
2W 630mA

**Kg** 0,07 Kg  
**Vol** 0,6 dm<sup>3</sup>

Wh	91962
Bl	91963
Ni	91964

○ N 189 lm  
○ W 166 lm

- ▲ 08 8°
- ▲ 15 15°
- ▲ 30 30°
- ▲ 60 60°
- ▲ 12 120° Mono

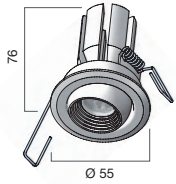

**3 LEDs**  
6W 630mA

**Kg** 0,09 Kg  
**Vol** 0,6 dm<sup>3</sup>

Wh	91971
Bl	91972
Ni	91973

○ N 568 lm  
○ W 498 lm

- ▲ 15 15°
- ▲ 30 30°
- ▲ 60 60°
- ▲ 12 120° Mono

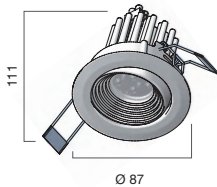

**3 LEDs**  
6W 630mA

**Kg** 0,24 Kg  
**Vol** 1,2 dm<sup>3</sup>

Wh	92927
Bl	92928
Ni	92929

○ N 568 lm  
○ W 498 lm

- ▲ 15 15°
- ▲ 30 30°
- ▲ 60 60°
- ▲ 12 120° Mono

**4 LEDs**  
8W 630mA

**Kg** 0,24 Kg  
**Vol** 1,2 dm<sup>3</sup>

Wh	92930
Bl	92931
Ni	92932

○ N 757 lm  
○ W 664 lm

- ▲ 15 15°
- ▲ 30 30°
- ▲ 60 60°

**6 LEDs**  
12W 630mA

**Kg** 0,24 Kg  
**Vol** 1,2 dm<sup>3</sup>

Wh	91977
Bl	91978
Ni	91979

○ N 1135 lm  
○ W 997 lm

- ▲ 08 8°
- ▲ 30 30°
- ▲ 60 60°
- ▲ 12 120° Mono

ELETTRONICA  
ELECTRONICS

- 1-2 LEDs 630mA 89147
- 1-6 LEDs 630mA 89164
- 6-12 LEDs 630mA 84766

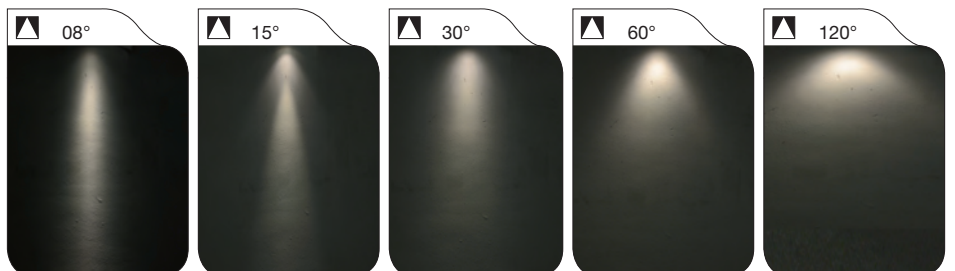

# FRAMELESS

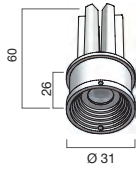

## 1 LED 2W 630mA

**Kg** 0,07 Kg  
**Vol** 0,2 dm<sup>3</sup>

<b>Wh</b>	<b>91941</b>
<b>Bl</b>	<b>91942</b>
<b>Ni</b>	<b>91943</b>

**N** 189 lm  
**W** 166 lm

<b>▲ 08</b>	8°
<b>▲ 15</b>	15°
<b>▲ 30</b>	30°
<b>▲ 60</b>	60°
<b>▲ 12</b>	120° Mono

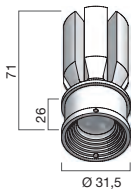

## 3 LEDs 6W 630mA

**Kg** 0,09 Kg  
**Vol** 0,2 dm<sup>3</sup>

<b>Wh</b>	<b>91950</b>
<b>Bl</b>	<b>91951</b>
<b>Ni</b>	<b>91952</b>

**N** 568 lm  
**W** 498 lm

<b>▲ 15</b>	15°
<b>▲ 30</b>	30°
<b>▲ 60</b>	60°
<b>▲ 12</b>	120° Mono

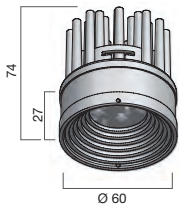

## 3 LEDs 6W 630mA

**Kg** 0,18 Kg  
**Vol** 1,2 dm<sup>3</sup>

<b>Wh</b>	<b>92933</b>
<b>Bl</b>	<b>92934</b>
<b>Ni</b>	<b>92935</b>

**N** 568 lm  
**W** 498 lm

<b>▲ 15</b>	15°
<b>▲ 30</b>	30°
<b>▲ 60</b>	60°
<b>▲ 12</b>	120° Mono

## 4 LEDs 8W 630mA

**Kg** 0,18 Kg  
**Vol** 1,2 dm<sup>3</sup>

<b>Wh</b>	<b>92936</b>
<b>Bl</b>	<b>92937</b>
<b>Ni</b>	<b>92938</b>

**N** 757 lm  
**W** 664 lm

<b>▲ 15</b>	15°
<b>▲ 30</b>	30°
<b>▲ 60</b>	60°

## 6 LEDs 12W 630mA

**Kg** 0,18 Kg  
**Vol** 1,2 dm<sup>3</sup>

<b>Wh</b>	<b>91956</b>
<b>Bl</b>	<b>91957</b>
<b>Ni</b>	<b>91958</b>

**N** 1135 lm  
**W** 997 lm

<b>▲ 08</b>	8°
<b>▲ 30</b>	30°
<b>▲ 60</b>	60°
<b>▲ 12</b>	120° Mono

### CONTROCASSE OUTER-CASINGS

 **SPOT Ø35 mm** **89389**

 **SPOT Ø65 mm** **89388**

### ELETTRONICA ELECTRONICS

 **1-2 LEDs 630mA** **89147**

 **1-6 LEDs 630mA** **89164**

 **6-12 LEDs 630mA** **84766**

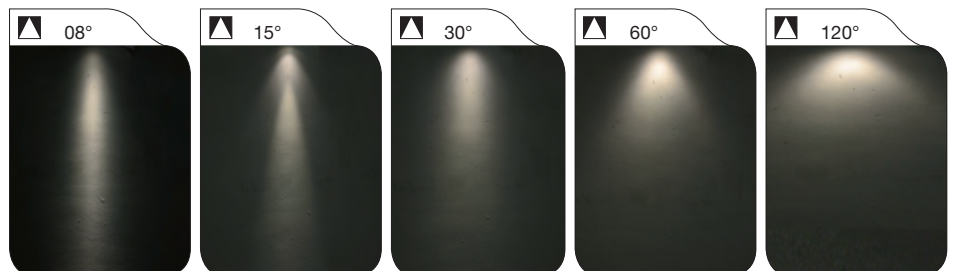

# CUADRO



85  
CRI

TOP  
LEDs

95%  
OPTICS



Sistema modulare da incasso con molle per controsoffitto.

Garantisce un ottimo comfort visivo grazie ad un circuito MultiLED antiabbagliamento.

È possibile scegliere SPOTS da 1 a 4 LEDs con corpi di diverse dimensioni (da  $\square 66$  mm a  $\square 95$  mm) e in moduli da 1 a 3 corpi illuminanti per accontentare tutte le esigenze.

Il corpo è in pressofusione di alluminio, disponibile nelle colorazioni bianco, nero, grigio e nichel spazzolato, orientabile di  $\pm 30^\circ$  sull'asse verticale ( $\pm 36^\circ$  nella versione 1 LED) e di  $\pm 16^\circ$  sull'asse orizzontale ( $\pm 23^\circ$  nella versione 1 LED).

È possibile scegliere tra un'ampia varietà di ottiche a seconda delle esigenze: con l'ottica  $8^\circ$  è possibile esaltare, con un'illuminazione d'accento, dettagli e caratteristiche dei prodotti esposti; con la lente MONO OPTIC  $120^\circ$  si ottiene un'illuminazione ambientale nitida che garantisce il massimo comfort visivo.

Driver compreso unicamente nelle versioni da 2 e 3 moduli da 4 LEDs

*Recessed modular system fitted with self-retaining clips for false ceiling mounting.*

*It provides perfect visual comfort thanks to the MultiLED anti-glare system.*

*SPOTS are available with 1 to 4 LEDs and different sized bodies (from  $\square 66$ mm to  $\square 95$ mm) as 1 to 3 luminaire modules to answer all needs.*

*Pressure die-cast aluminium body available in white, black, grey and brushed nickel finishes. It can be adjusted  $\pm 30^\circ$  on the vertical axis ( $\pm 36^\circ$  for the 1 LED version) and  $\pm 16^\circ$  on the horizontal axis ( $\pm 23^\circ$  for the 1 LED version).*

*Wide range of optics to answer all needs.  $8^\circ$  optics for accent lighting highlighting details and features of products on display and  $120^\circ$  MONO OPTIC lens to provide clear lighting for perfect visual comfort.*

*Driver included only in the versions with two or three 4-LED modules.*

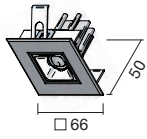

**1 LED**  
2W 630mA

**Kg** 0,08 Kg  
**Vol** 0,65 dm<sup>3</sup>

Ni	91008
Wh	91009
Bl	91010
Gr	91011

● **N** 189 lm  
● **W** 166 lm

▲ **15** 15°  
▲ **30** 30°  
▲ **60** 60°  
▲ **12** 120° Mono

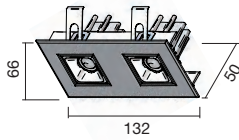

**2x1 LED**  
4W 630mA

**Kg** 0,16 Kg  
**Vol** 1,84 dm<sup>3</sup>

Ni	91032
Wh	91033
Bl	91034
Gr	91035

● **N** 2 x 189 lm  
● **W** 2 x 166 lm

▲ **15** 15°  
▲ **30** 30°  
▲ **60** 60°  
▲ **12** 120° Mono

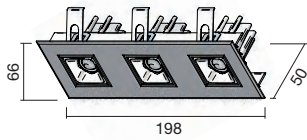

**3x1 LED**  
6W 630mA

**Kg** 0,23 Kg  
**Vol** 3,16 dm<sup>3</sup>

Ni	91056
Wh	91057
Bl	91058
Gr	91059

● **N** 3 x 189 lm  
● **W** 3 x 166 lm

▲ **15** 15°  
▲ **30** 30°  
▲ **60** 60°  
▲ **12** 120° Mono

**CONTROCASSE**  
OUTER CASINGS



**CUADRO 1LED 84793**

**ELETRONICA**  
ELECTRONICS



**1-2 LEDs 630mA 89147**



**1-6 LEDs 630mA 89164**



**6-12 LEDs 630mA 84766**

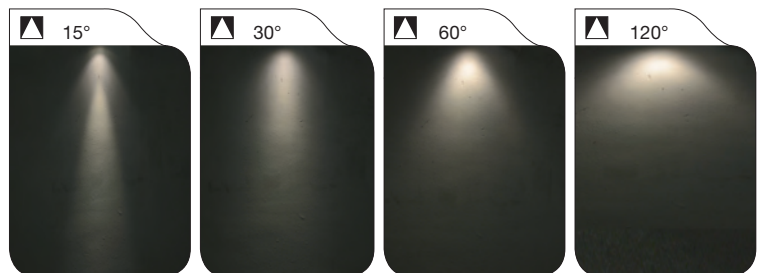
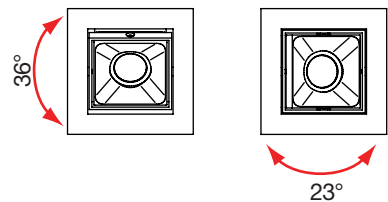



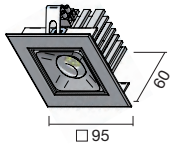

**4 LEDs**  
7W 500mA

**Kg** 0,18 Kg  
**Vol** 2,1 dm<sup>3</sup>



**Senza alimentatore**  
**Without driver**

Ni	91016
Wh	91017
Bl	91018
Gr	91019

**N** 581 lm  
**W** 510 lm

**▲ 15** 15°  
**▲ 30** 30°  
**▲ 60** 60°

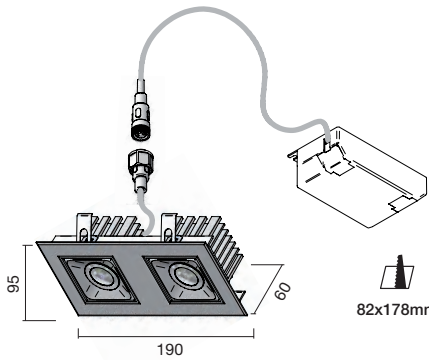

**2x4 LED**  
14W

**Kg** 0,37 Kg  
**Vol** 2,7 dm<sup>3</sup>



**Alimentatore compreso**  
**Driver included**

Ni	91040
Wh	91041
Bl	91042
Gr	91043

**N** 2 x 581 lm  
**W** 2 x 510 lm

**▲ 15** 15°  
**▲ 30** 30°  
**▲ 60** 60°

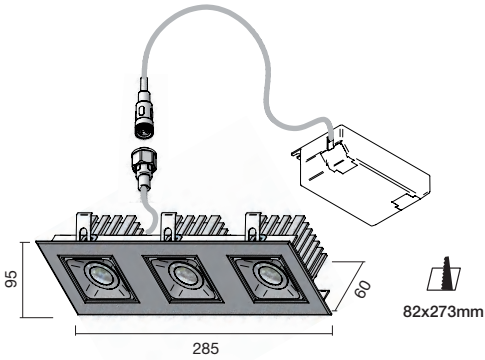

**3x4 LEDs**  
20W

**Kg** 0,56 Kg  
**Vol** 3,6 dm<sup>3</sup>



**Alimentatore compreso**  
**Driver included**

Ni	91064
Wh	91065
Bl	91066
Gr	91067

**N** 3 x 581 lm  
**W** 3 x 510 lm

**▲ 15** 15°  
**▲ 30** 30°  
**▲ 60** 60°

**CONTROCASSE**  
**OUTER CASINGS**

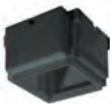

**CUADRO 4 LEDs** 84797

**ELETRONICA**  
**ELECTRONICS**



**1-6 LEDs 500mA** 89163



**6-12 LEDs 500mA** 84830

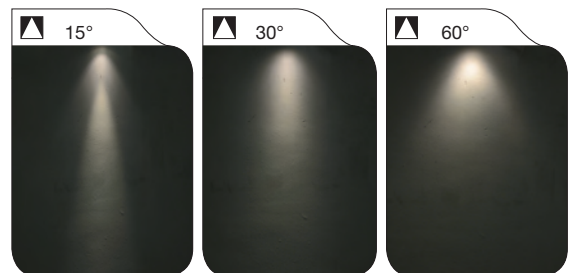
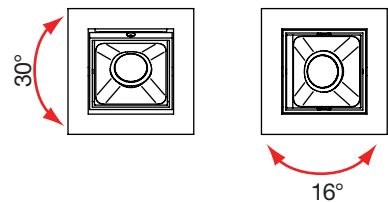



# SQUARE



85  
CRI

TOP  
LEDs

95%  
OPTICS



Innovativi e performanti faretto quadri da incasso a soffitto, caratterizzato da dimensioni ridotte è un prodotto particolarmente versatile e discreto.

Garantisce un ottimo comfort visivo grazie ad un circuito MultiLED arretrato su di un anello antiabbagliamento.

È possibile scegliere SQUARE da 1 a 12 LEDs, con cornice a vista o a scomparsa per controsoffitto e con ottica fissa o basculante per venire incontro a tutte le esigenze.

Il corpo è in pressofusione di alluminio, disponibile nelle colorazioni bianco, nero e nichel spazzolato.

È disponibile un'ampia varietà di ottiche: da 8° ai 60° MULTILENS ai 120° MONO OPTIC per ottenere un'illuminazione ambientale nitida che garantisca il massimo comfort visivo.

Gli SQUARE da 9 e 12 LEDs vengono forniti con alimentatore completi di cavo e connettori rapidi.

Nelle versioni più piccole l'alimentazione non è compresa.

*These innovative high-performance compact square recessed spotlights represent an extremely versatile subtle lighting system.*

*It provides perfect visual comfort thanks to the recessed MultiLED system with anti-glare ring.*

*SQUARE is available with 1 to 12 LEDs, with or without frame for false ceilings and with a choice of fixed and tilting optics to meet all needs.*

*Pressure die-cast aluminium body available in white, black and brushed nickel finishes.*

*Wide range of optics available: from 8° to 60° MULTILENS and 120° MONO OPTIC for bright ambient lighting ensuring maximum visual comfort.*

*SQUARE with 9 and 12 LEDs are supplied with power supply unit. Power supply unit is not included with the smaller versions.*

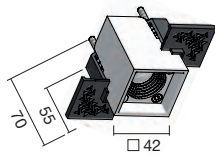

**1 LED**  
2W 630mA

**Kg** 0,14 Kg  
**Vol** 0,65 dm<sup>3</sup>

<b>Wh</b>	<b>92115</b>	<b>N</b> 189 lm	<b>▲08</b> 8°
<b>Bl</b>	<b>92116</b>	<b>W</b> 166 lm	<b>▲15</b> 15°
			<b>▲30</b> 30°
			<b>▲60</b> 60°
			<b>▲12</b> 120° Mono

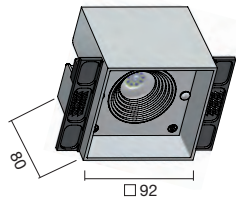

**6 LEDs**  
12W 630mA

**Kg** 0,6 Kg  
**Vol** 2 dm<sup>3</sup>

<b>Wh</b>	<b>92122</b>	<b>N</b> 1135 lm	<b>▲08</b> 8°
<b>Bl</b>	<b>92123</b>	<b>W</b> 997 lm	<b>▲30</b> 30°
			<b>▲60</b> 60°
			<b>▲12</b> 120° Mono



**ELETRONICA  
ELECTRONICS**

-  1-2 LEDs 630mA **89147**
-  1-6 LEDs 630mA **89164**
-  6-12 LEDs 630mA **84766**

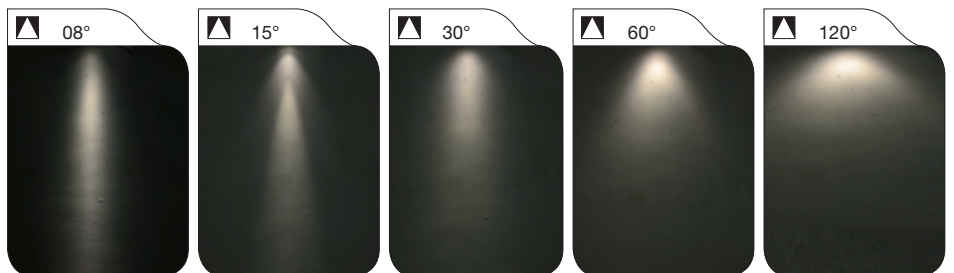

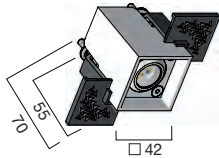

**1 LED**  
2W 630mA

**Kg** 0,27 Kg  
**Vol** 0,65 dm<sup>3</sup>

Wh	92130
Bl	92131

**N** 189 lm  
**W** 166 lm

- ▲ 08 8°
- ▲ 15 15°
- ▲ 30 30°
- ▲ 60 60°
- ▲ 12 120° Mono

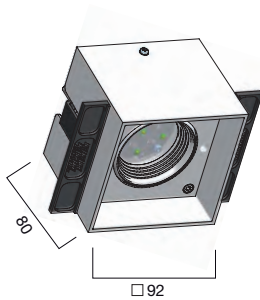

**6 LEDs**  
12W 630mA

**Kg** 0,9 Kg  
**Vol** 2 dm<sup>3</sup>

Wh	92140
Bl	92141

**N** 1135 lm  
**W** 997 lm

- ▲ 08 8°
- ▲ 30 30°
- ▲ 60 60°
- ▲ 12 120° Mono

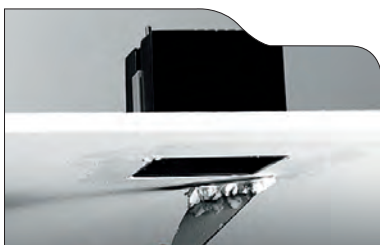
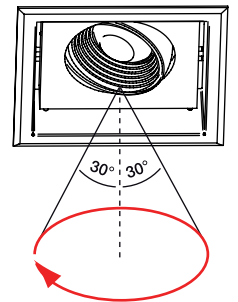

ELETRONICA  
ELECTRONICS

-  1-2 LEDs 630mA 89147
-  1-6 LEDs 630mA 89164
-  6-12 LEDs 630mA 84766

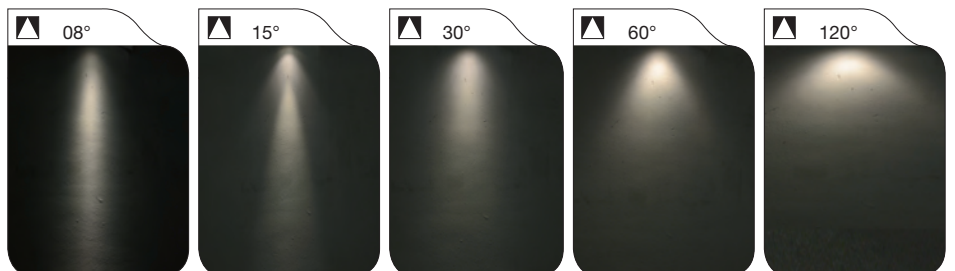

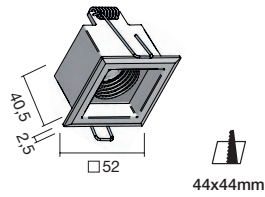

**1 LED**  
2W 630mA

**Kg** 0,1 Kg  
**Vol** 0,65 dm<sup>3</sup>

Wh	92148
Bl	92149

**N** 189 lm  
**W** 166 lm

- ▲ 08 08°
- ▲ 15 15°
- ▲ 30 30°
- ▲ 60 60°
- ▲ 12 120° Mono

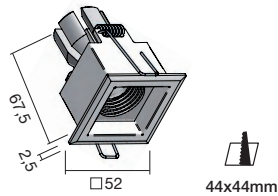

**3 LEDs**  
6W 630mA

**Kg** 0,14 Kg  
**Vol** 0,65 dm<sup>3</sup>

Wh	92154
Bl	92155

**N** 568 lm  
**W** 498 lm

- ▲ 15 15°
- ▲ 30 30°
- ▲ 60 60°
- ▲ 12 120° Mono

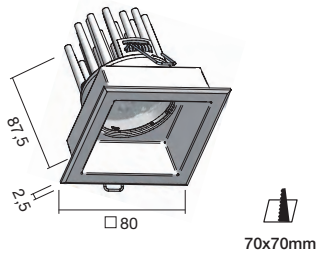

**6 LEDs**  
12W 630mA

**Kg** 0,2 Kg  
**Vol** 1,28 dm<sup>3</sup>

Wh	92999
Bl	93000

**N** 1135 lm  
**W** 997 lm

- ▲ 08 8°
- ▲ 30 30°
- ▲ 60 60°

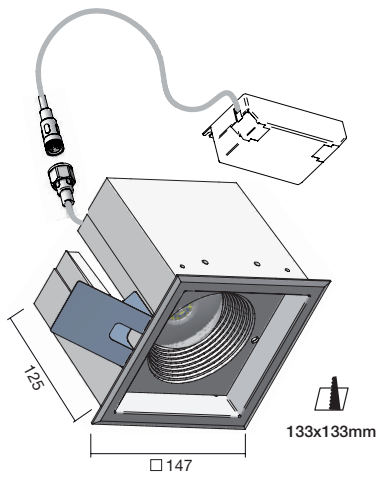

**9 LEDs**  
18W

**Kg** 0,8 Kg  
**Vol** 9,7 dm<sup>3</sup>

Wh	92158
Bl	92159

**Alimentatore compreso Driver included**

**N** 1703 lm  
**W** 1495 lm

- ▲ 15 15°
- ▲ 30 30°
- ▲ 60 60°
- ▲ 12 120° Mono

**12 LEDs**  
24W

**Kg** 0,8 Kg  
**Vol** 9,7 dm<sup>3</sup>

Wh	92160
Bl	92161

**ON/OFF**

**N** 2270 lm  
**W** 1993 lm

- ▲ 08 8°
- ▲ 15 15°
- ▲ 30 30°
- ▲ 60 60°
- ▲ 12 120° Mono

**ELETRONICA ELECTRONICS**

- 1-2 LEDs 630mA **89147**
- 1-6 LEDs 630mA **89164**
- 6-12 LEDs 630mA **84766**

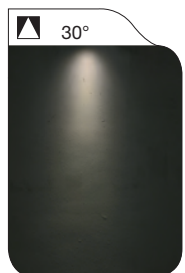
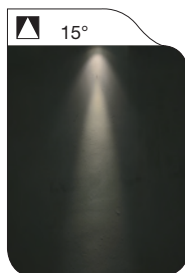
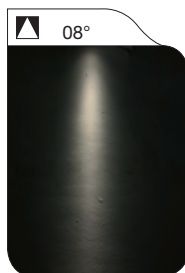

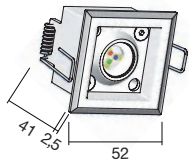

**1 LED**  
2W 630mA

**Kg** 0,14 Kg  
**Vol** 0,65 dm<sup>3</sup>

Wh	92164
Bl	92165

○ N 189 lm  
○ W 166 lm

- ▲ 08 8°
- ▲ 15 15°
- ▲ 30 30°
- ▲ 60 60°
- ▲ 12 120° Mono

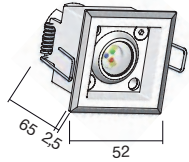

**3 LEDs**  
6W 630mA

**Kg** 0,17 Kg  
**Vol** 0,65 dm<sup>3</sup>

Wh	92170
Bl	92171

○ N 568 lm  
○ W 498 lm

- ▲ 15 15°
- ▲ 30 30°
- ▲ 60 60°
- ▲ 12 120° Mono

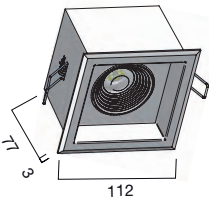

**6 LEDs**  
12W 630mA

**Kg** 0,7 Kg  
**Vol** 2 dm<sup>3</sup>

Wh	92174
Bl	92175

○ N 1135 lm  
○ W 997 lm

- ▲ 08 8°
- ▲ 30 30°
- ▲ 60 60°
- ▲ 12 120° Mono

**9 LEDs**  
18W

**Kg** 0,8 Kg  
**Vol** 9,7 dm<sup>3</sup>

**ON/OFF**



**Alimentatore compresso Driver included**

Wh	92178
Bl	92179

○ N 1703 lm  
○ W 1495 lm

- ▲ 15 15°
- ▲ 30 30°
- ▲ 60 60°
- ▲ 12 120° Mono

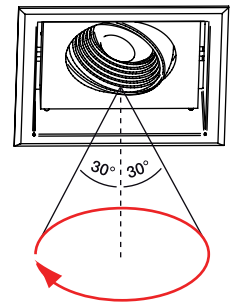
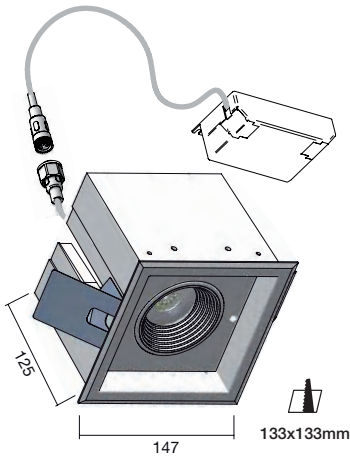

**ELETRONICA ELECTRONICS**

- 1-2 LEDs 630mA **89147**
- 1-6 LEDs 630mA **89164**
- 6-12 LEDs 630mA **84766**

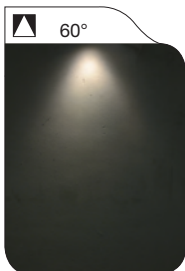
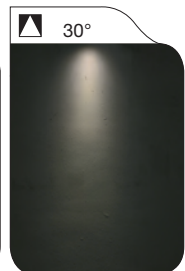
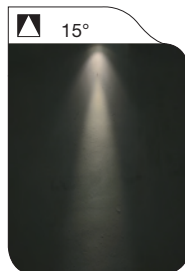
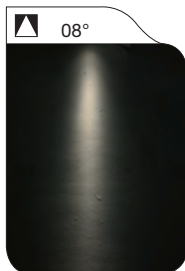



AP  
AUDEMARS PIGUET

